

Hunter®

 **Hydrawise™ Ready**
IRRIGATION CONTROLLERS

Hydrawise Software/App Owner's Manual



hydrawise.com

Table of Contents

Table of Contents	2
Flow Meter Pressure Loss Chart	3
How to Configure Your Flow Meter	3
Flow Meter Installation Quick Start Guide	6
The flow meter consists of two parts:	6
The following instructions assume you have already installed your Hydrawise controller	7
Use your Hydrawise account to complete your flow meter configuration.	8
Flow Meter Installation Tips	9
HC Flow Meter Specifications	12
Reading Meter	13
How to Configure a Custom Flow Meter	15
Using One Flow Meter for Two Controllers	16
Winterization - Bypassing a Flow Meter	17
Wire Distance (Controller to Valve)	20
Pump Start Relay Wiring and Software Setup	21
One Master Valve - Two Controllers	26
Master Valve Wiring and Software Setup	27
Sprinklers Running with the Controller Off or Unplugged	32

Flow Meter Pressure Loss Chart

HC FLOW METER PRESSURE LOSS CHART

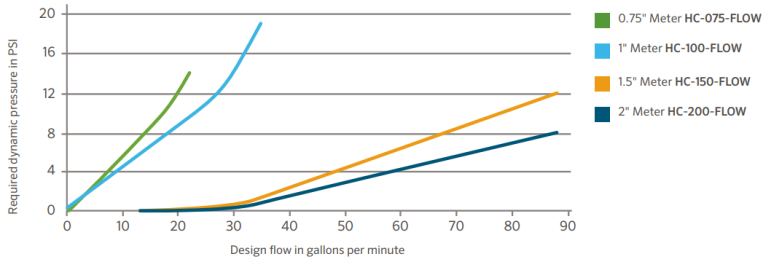

How to Configure Your Flow Meter

Assigning the Meter

Please view the steps and screenshots to access this feature:

1. Click on **SENSORS** from the home dashboard.
2. Click on **ADD SENSOR TO CONTROLLER**.
3. Choose a **NAME**, **SENSOR TYPE**, and **INPUT** (flow-related only).
4. Choose which **ZONES** should be linked to the sensor.
5. Click **OK** when finished.

Step 1



IRRIGATION CONTRACTOR
WE WATER



Mr King - Belmont
IRRIGATION CONTRACTOR



Home



Zones & Schedules >



Watering Triggers



Sensors



Controller Settings



Reports

Step 2

Sensors

Hydrawise supports standard rain sensors, soil moisture sensors and open/closed contact flow meters. [+](#)



Add Sensor to Controller

Step 3

Add Sensor ✕

Sensor details ▸ Set zones

Sensor Name

Assign a descriptive name for this sensor

Flow Meter

Type of Sensor

Choose the type of sensor you have installed. You can also create a custom sensor type if you have something non standard.

¼ inch NPT Flow Meter

Create New Sensor Type...

Controller Input

Choose the input on the controller that this sensor is wired to

SEN-1

Cancel < Prev Next > ✓ OK

Step 4

Add Sensor ✕

Sensor details ▸ Set zones

Select Zones

Select the zones which will use this sensor

Available zones	Selected zones
Carioca Court	Carioca Court
Back Grass	Front Grass
Back Drip	Street Drip
Diamond Street Controller	Front Drip
Front Grass	
Front Flowers	
Back Drip	

Cancel < Prev Next > ✓ OK

Flow Meter Installation Quick Start Guide

In this Quick Start Guide, you will learn how to install and configure your flow meter. For support of Hydrowise™ cloud software or help with your Hydrowise account, visit the support section [here](#) [1]. For specification information, refer to the section [here](#) [2].

The flow meter consists of two parts:

1. Flowmeter body: The flowmeter body contains an analog dial for manual readings as follows. Your flow meter will have 3 wires protruding from the body. The wires need to be connected to the sensor inputs on the controller for readings in the software application. In all models, only 2 wires (blue and white) are used.

2. Adapter: Each flow meter has an adapter to allow connection to your irrigation system.

DIAL MARKING	MEASUREMENT UNIT
X0.01	0.1 gallon
X1	1 gallon
X10	10 gallons
X100	100 gallons

3. Flowmeter location: Flow meters are installed between the master valve and zone valves. To avoid false alerts, there should be no water taps or other uncontrolled water use on the downstream side of the flow meter. If all solenoids connected to the controller are not grouped together, it may be necessary to install more than one flow meter. For proper installation and optimal water flow, use the chart below when determining pipe length. The pipe bringing water into the flow meter needs to be 10 times longer than the width of the pipe. The pipe carrying water away from the meter needs to be 5 times the width of the pipe.

PIPE	10X-BEFORE	5X-AFTER
¾"	7½"	3¾"
1"	10"	5"
1½"	15"	7½"
2"	20"	10"

4. Cable (shielded direct-burial cable must be used): Two-wire cable is required. The cable gauge is determined by the total length of cable between the controller and the flow meter. The cable should consist of 2 dedicated wires and must not be in the same conduit or cable bunch as the solenoid wires. Do not share the common wire of the solenoids with the common of the sensors. If desired, the flex cable can be used to run inside the conduit. That flex cable measures ¼" BSP, which also fits ¼" NPT.

Flow Meter Cable Length Chart

WIRE SIZE	MAX LENGTH
Gauge	Feet
20	240
18	1,000

IMPORTANT: Shielded direct-burial cable is commonly available. Manufacturers include Paige Electric and Regency Wire.

The following instructions assume you have already installed your Hydrowise controller

1. Flowmeter body: The flow meter has a marking on the body indicating the direction of water flow. Installation of the flow meter must be in the correct orientation with water flowing in the direction of the arrow on the flow meter body. All HC Flow Meters must be installed horizontally with the dial facing upward.

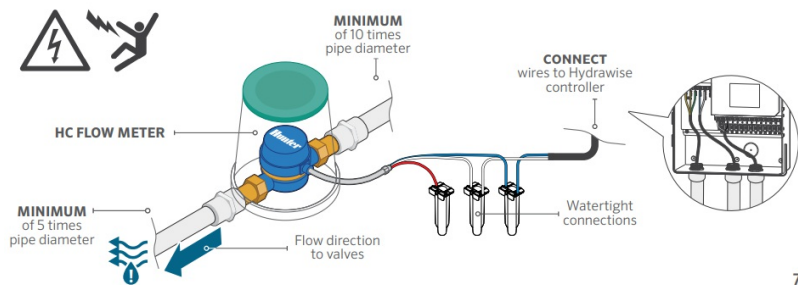

7

2. Connect flowmeter wire: Two-wire cable is required. The cable required to connect your flow meter must be dedicated to the flow meter and not shared with the common wire of the valves or other sensors. The cable gauge is determined by the total length of cable between the controller and the flow meter. The general rule is that 0.5 mm (20GA) wire is good for a run of up to 240'. Connect the wires to your Hydrawise controller.

WIRE COLOR	SENSOR TERMINAL BLOCK
White	Common
Blue	Sen 1 or Sen 2
Red	Not used: Wires should be capped with waterproof splice

* Shield and bare wire should be connected to the controller ground terminal if available.

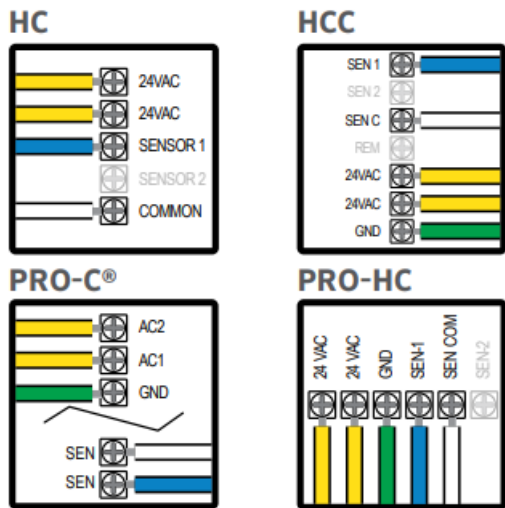

IMPORTANT: All wire connections should be done using waterproof connectors, such as 3M 316IR or 3M DBY.

Use your Hydrawise account to complete your flow

meter configuration.

- 1. Log in to your account:** Enter your login information.
- 2. Create a flow sensor:** It is important that you select the correct flow meter when configuring your Hydrawise app. Choosing the wrong model may cause the Hydrawise controller to create false alerts in the software.

HC FLOW METER SELECTION CHART		
METER SIZE	DESCRIPTION	U.S. GALLON PULSE RATE
¾"	¾" flow meter	1 pulse per 0.1 gallon
1"	1" flow meter	1 pulse per 1 gallon
1½"	1½" flow meter	1 pulse per 1 gallon
2"	2" flow meter	1 pulse per 1 gallon

- 3. Assign zones to the flow sensor:** Refer to this [support article](#) ^[3] for setup information.

Flow Meter Installation Tips

Flow meters are supplied with [detailed installation instructions](#) ^[4].

The flow meter wires need to be cabled back to the controller and connected to the **Sensor** inputs on the controller. Check out the illustrations below for wiring standard Hydrawise flow meters to each of the model controllers (Sizes include ¾", 1", 1.5", and 2")

HC

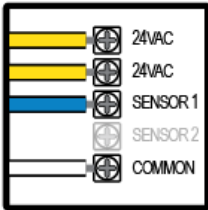

HCC

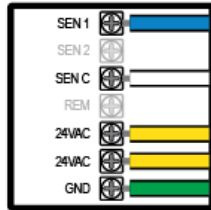

PRO-HC



HPC (Jan 2023 Newer)

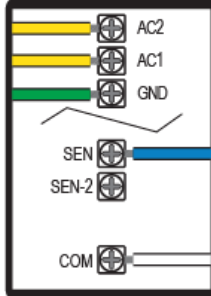

HPC

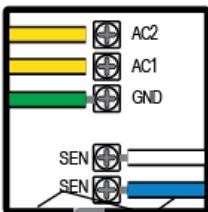

The tips below include all the necessary key points of the installation to avoid any false alerts or readings.

Installation Steps	Description															
Flow Meter Body	Flow meters are designed to be installed horizontally only , with the dial facing up. Not vertically. Analog dial for manual readings in U.S. are shown in US gallons (Int. customers the dial reads in Cubic Meters). Units can be changed in App to gallons or liters.															
Adapter	Brass unions included to fit your irrigation system.															
Entry Location	<p>Install between the master valve and zone valves. Meter should be installed 10 times pipe diameter before and 5 times after with straight pipe and no fittings. See example:</p> <table border="1"> <thead> <tr> <th>Pipe</th> <th>10x-Before</th> <th>5x-After</th> </tr> </thead> <tbody> <tr> <td>3/4"</td> <td>7.5"</td> <td>3.75"</td> </tr> <tr> <td>1"</td> <td>10"</td> <td>5"</td> </tr> <tr> <td>1.5"</td> <td>15"</td> <td>7.5"</td> </tr> <tr> <td>2"</td> <td>20"</td> <td>10"</td> </tr> </tbody> </table>	Pipe	10x-Before	5x-After	3/4"	7.5"	3.75"	1"	10"	5"	1.5"	15"	7.5"	2"	20"	10"
Pipe	10x-Before	5x-After														
3/4"	7.5"	3.75"														
1"	10"	5"														
1.5"	15"	7.5"														
2"	20"	10"														

Cable used (shielded cable only)	18 gauge - 1000 foot max Length. Shielded direct burial cable must be used. Cable should consist of two dedicated wires and must not be in the same conduit, cable bundle or trench as the solenoid wires. DO NOT share common wire. Shielded cable is commonly available, here are some manufacturers (Paige ^[5] & Regency ^[6]) For additional information on avoiding electrical interference, see below:
Flow meter body	Arrow indicates direction of flow.
Wire Connection	Blue/White wire only, red not used. See sensor configuration ^[7] for more info based on model controller.
Log in to your account	Enter your login ^[8] information.
Create your flow sensor	App will show options for all HC meters.
Creating Alerts	See link here ^[9]
Reading Meter	See link here ^[10]
Testing Meter	See link here ^[11]

Avoid Electrical Interference

- Always use shielded cable, between the controller and the HC Flow Meter.
- At the controller end, using the shield (foil wrap) and the bare wire connect them to the controller GND terminal (not required for HC controllers).
- Do not connect the other end of the Shield or the bare wire to the Earth or a grounding stake
- Use Waterproof wire connectors at the flow meter, such as the [3M-DBOB](#) ^[12].
- Shielded cable is commonly available, here are some manufacturers. [Paige](#) ^[5] & [Regency](#) ^[6]

HC Flow Meter Specifications

HC FLOW METER SPECIFICATIONS

HC Flow Model	HC-075-FLOW (¾")	HC-100-FLOW (1")	HC-150-FLOW (1½")	HC-200-FLOW (2")
Inlet/outlet connection size	¾" NPT body, male thread	1" NPT body, male thread	1½" NPT body, male thread	2" NPT body, male thread
Meter internal diameter	¾"	1"	1.5"	2"
Minimum flow (GPM)	0.22	0.3	0.88	1.98
Maximum recommended flow (GPM)	15	30	66	105
Maximum flow rate (GPM)	21	34	88	132
Dial reading (US gal)	1 pulse per 0.1 U.S. gal	1 pulse per 1 U.S. gal	1 pulse per 1 U.S. gal	1 pulse per 1 U.S. gal
Maximum working pressure (PSI)	230	230	230	230
Included Wire Length	29" total wire length with first 8" having flex conduit.			
Flex Conduit Thread Spec	Threading measures ¼" BSP, which would also fit ¼" NPT for all models. The exact thread size of the stainless steel fitting is 1/4-28.			

HC FLOW METER Pressure Loss Chart

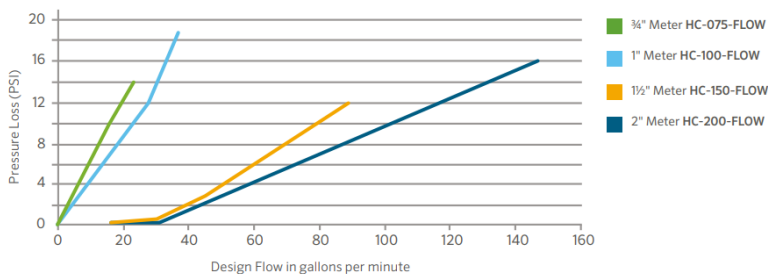

Reading Meter

The Hydrowse flow meters come in a US Gallon reading for domestic and metric reading called M³ (Meters Cubed 1000 Liters) for international. The conversion rate for metric meters is 3.78 Liters to 1 US Gallon if required.

See an example of meter reading below in US gallons:

Fig. 1	X100	8100 Gallons
Fig. 2	X10	814X.XX Gallons
Fig. 3	X1	8142.XX Gallons
Fig. 4	X0.1	8142.4X Gallons
Fig. 5	X0.01	8142.46 Gallons Total
Fig. 6	Size meter	1"
Fig. 7	Flow Indicator	Wheel spins when water is flowing.
Fig. 8	Pulse Transmitter	1-1/2" (40mm) & 2"(50mm) flow meter models

We have a flow that has gone through the meter of 8,142.46 gallons.

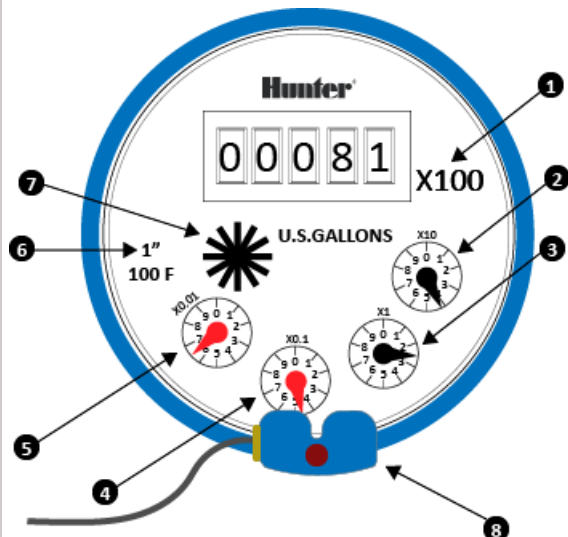

See an example of meter reading below in Litres:

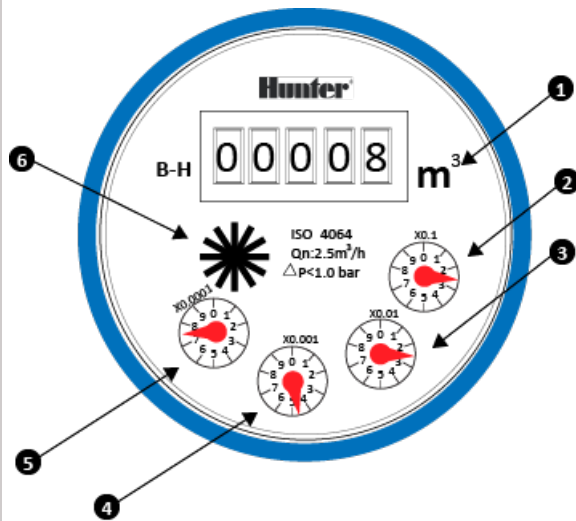

Fig. 1	8,000 Litres
Fig. 2	8,200 Litres
Fig. 3	8,220 Litres
Fig. 4	8,224 Litres
Fig. 5	8,224.7 Litres Total
Fig. 6	The wheel spins when water is flowing.



So we have a flow that has gone through the meter of 8,224.7 Litres. To calculate this into Gallons is easy $8,224.7 / 3.78 = 2175.84$ gallons.

How to Configure a Custom Flow Meter

If you choose to use a flow meter from another manufacturer with a reed switch output, please make sure the configuration is set up under **CUSTOM SENSOR TYPE**.

1. Log in to the [Hydrawise app](#) [8].
2. Click the  **MENU** icon on the upper left-hand side.
3. Select the  **SENSORS** option.
4. Select **CUSTOM SENSOR TYPE**.
5. Select **ADD CUSTOM SENSOR TYPE**.
6. A dialogue box will appear for you to enter your custom flow meter details. Make sure you enter the calibration details for your custom, pulse-based flow meter. Please refer to the manufacturer specifications to determine the calibration. Otherwise, you will not receive accurate readings to display on your flow data.

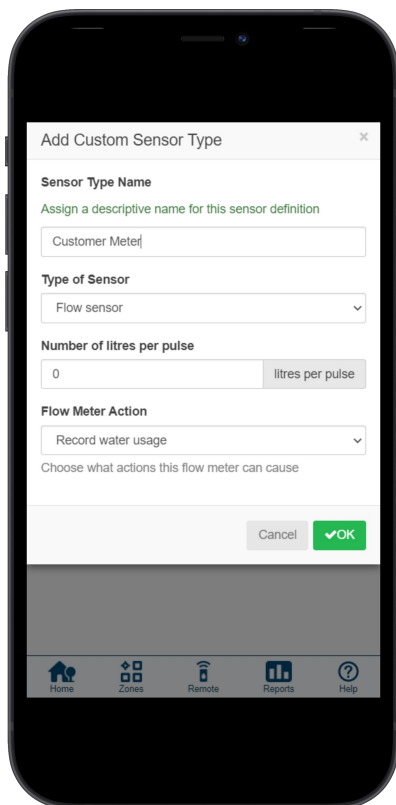

NOTE: For our system to detect the correct flow data and reflect it on your **Dashboard** reports, any third-party

flow meter used must be a true pulse flow meter or have a reed switch. We aim for a minimum of 10 pulses per min and a maximum of 120 pulses per min. That means if the flow rate was 10 gal per min, 1 pulse per gallon needs to be set.

When using a third-party flow meter, please ensure it meets the specs above and is calibrated correctly. Otherwise, data will not reflect accurately in reports. Also, note that the wiring is not polarity sensitive. As long as you have one wire in a **Sensor Port** and a **Sensor Common**, the device will work correctly. For flow meters that use three wires and meet the specs above, configure the wiring until you find the two correct wires to use.

Using One Flow Meter for Two Controllers

For this installation, we suggest a few tips to make sure you do not receive any unnecessary alerts.

When using two controllers on the same flow meter, there are two alerts we do not recommend using.

1. **HIGH FLOW LEAK** - High water usage with no zones running.
2. **SLOW LEAK** - Water usage over last hour with no zones running.

These alerts are controller specific so when the controller with the flow meter is not in operation, it does know about the other controller operation.

Tips:

1. The inter station delay ^[13] should be set for 10-30 seconds. We do not recommend any higher.
2. Change the gallons in the alert to be **HIGHER** (e.g. alert from 5 gallons to 20 gallons).
3. Wire to only **ONE** of the two controllers.
4. Configure the sensor to the controller that has the wire connection.
5. Move **AVAILABLE** zones from both controllers into **SELECTED ZONES**.

For more information on configuring and wiring, visit support section [here](#) ^[14].

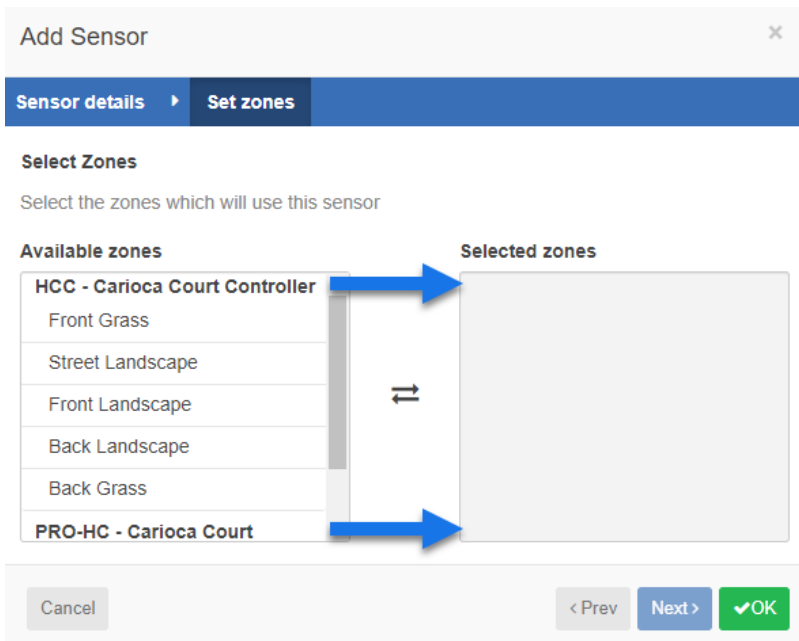

Following these parameters should allow the system to run normal when using one flow meter with multiple controllers.

Winterization - Bypassing a Flow Meter

Overview:

We recommend that a qualified licensed contractor perform this type of winterization method. The blowout method utilizes an air compressor with a cubic foot per minute (CFM) rating of 80-100 for any 2" or less mainline. The compressor is attached to the mainline via a quick coupler, hose bib, or other connections located beyond the backflow device. For additional winterization procedures, we highly recommend contacting the local dealer for the most common local practices.

IMPORTANT: Compressed air should not be blown through any backflow or flow meter device.

If you need to blow upstream from where the flow meter is located, we recommend bypassing the meter temporarily by using one of two options.

Bypass HC Flow Meter Using Nipple

See the size chart below for specific lengths to install an SCH 80 or galvanized nipple.

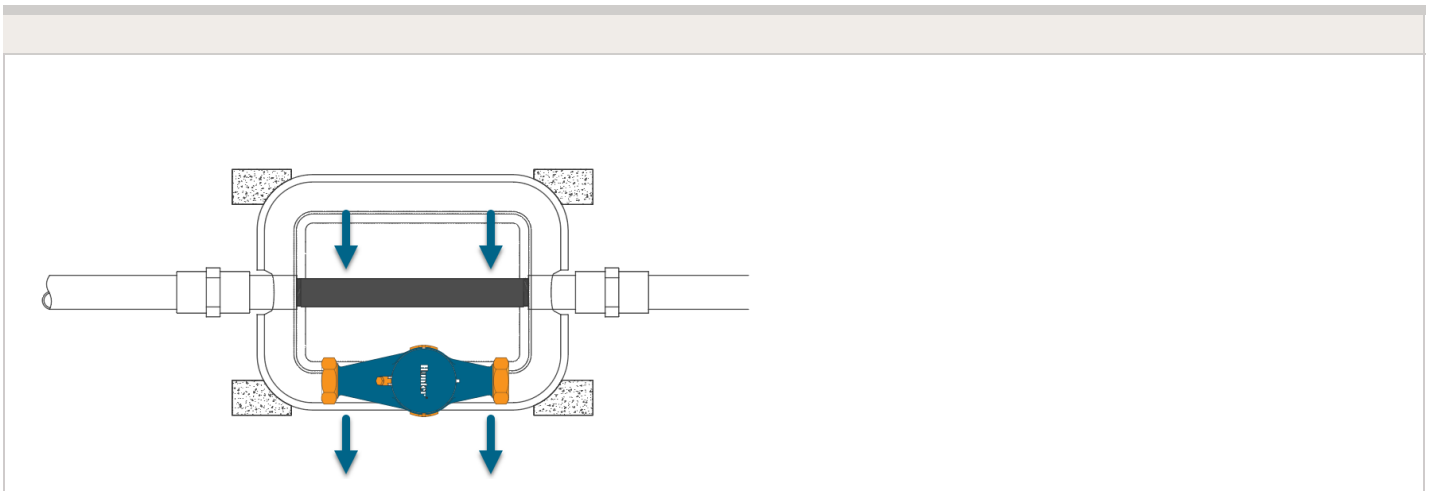

Model	Description	Male-Thread NPT	Nipple Length
HC-075-FLOW	¾" NPT body, male thread with 1" NPT male adapter	1" NPT	5"
HC-100-FLOW	1" NPT body, male thread with 1.5" NPT male adapter	1 ¼"NPT	5"
HC-150-FLOW	1½" NPT body, male thread with 2" NPT male adapter	2"NPT	11 ¾"
HC-200-FLOW	2" NPT body, male thread with 3" NPT male adapter	2 ½" BSP	11 ¾"

Bypass HC Flow Meter Using Shutoff Valves

A second option would be to install PVC tee-ball valves on each side of the meter. This is the recommended option during NEW installation. The meter will have to be removed manually after the blowout to make sure any residual water is not sitting inside through the winter months.

IMPORTANT: The pipe flowing water into the flow meter needs to be a **MINIMUM** of 10 times longer than the width of the pipe. The pipe flowing water away from the meter needs to be a **MINIMUM** of 5 times the width of the pipe.

1. Ball Valve 1
2. Ball Valve 2
3. Ball Valve 3 (Not necessary for winterizing but helpful for maintenance on the meter)
4. Bypass PVC pipe

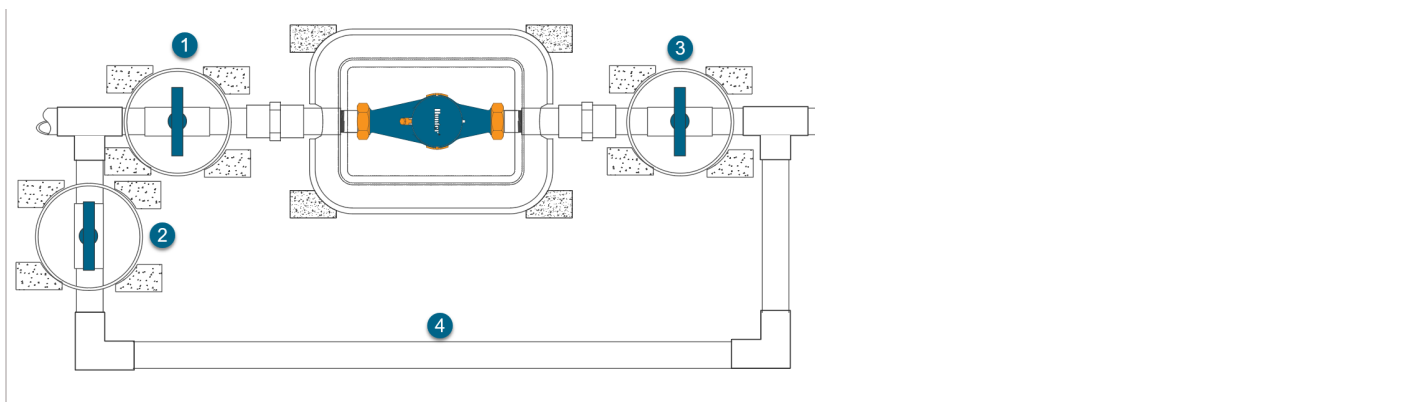

Find a Hunter Distributor closest to you using our interactive lookup - [Get Hunter](#)^[15]

Wire Distance (Controller to Valve)

The chart below indicates the maximum wire runs that can be used when installing Hunter AC solenoid valves with controllers. The example in the chart below demonstrates the most commonly used wire size for station control and ground wire (e.g., 12 AWG = 3390 feet).

NOTE: Valve Wire Sizing (Maximum One-Way Distance in Feet Between Controller and Valve)

Ground Wire (size)	Control Wire (FT)					
	18 AWG / 1.0 mm	16 AWG / 1.2 mm	14 AWG / 1.6 mm	12 AWG / 2.0 mm	10 AWG / 2.5 mm	8 AWG / 3 mm

18 AWG / 1.0 mm	850	1040	1210	1350	1460	1540
16 AWG / 1.2 mm	1040	1340	1650	1920	2150	2330
14 AWG / 1.6 mm	1210	1650	2150	2630	3080	3450
12 AWG / 2.0 mm	1350	1920	2630	3390	4170	4880
10 AWG / 2.5 mm	1460	2150	3080	4170	5400	6670
8 AWG / 3 mm	1540	2330	3450	4880	6670	8700

Pump Start Relay Wiring and Software Setup

In this article, we will discuss the following topics:

- Summary
- Operation Chart
- Wiring (24 VAC)
- Wiring to Power Source
- Software Setup
- Pump Start Relay Operation per Zone

Summary

When a system requires the use of a booster pump or pulls water directly from a creek or pond, it's imperative to include a relay to activate the pump each and every time. A pump start relay is a relay box that activates a pump every time a zone is activated from the controller. Zone valves are the individual valves that operate a group of sprinklers or drip emitters. Hydrowise controllers support 6- to 54-zone valves, depending on the model. Typically, one zone valve is turned on at a time and controls the irrigation in a specific area

of your landscape. Whenever one of the irrigation zone valves is told to open by the controller, the controller also signals the pump start relay to turn the pump on.

Operation Chart

Controller Model	Set Master Valve Operation
HC	ON or OFF by All Zones
PRO-HC	ON or OFF by All Zones
X2 w/WAND WiFi Module	ON or OFF by Zone or All Zones
HPC	ON or OFF by Zone or All Zones
HCC	ON or OFF by Zone or All Zones

Wiring (24 VAC)

Use a minimum distance of 15' (4.5 m) between the controller and the relay to dampen electromagnetic noise. In addition to this recommendation, Hunter also recommends all controllers be mounted 15' (4.5 m) away from pumps and high-voltage devices.

1. Detach the pump start relay cover plate by removing the four screws with a Phillips screwdriver.
2. Run a single wire from the "common" terminal on the controller to one of the yellow wires on the pump start relay.
3. Run a single wire from the "P/MV" terminal on the controller to the other yellow wire on the pump start relay.
4. Use wire nuts to make the connections and verify they are secure.
5. Install pump start relay cover plate and four screws. Close and lock the cabinet door.
6. Route wire through the conduit or one of the openings on the bottom of the cabinet.
7. Strip 1/2" (13 mm) of insulation from the ends of all wires. Secure the valve common wire to the "COM" (Common) terminal. Attach the opposite control wire to the M/V terminal.

Pump Start Relay Maximum Wire Lengths

MAXIMUM one-way wire length (do not go this far!)						
Model	18 AWG	16 AWG	14 AWG	12 AWG	10 AWG	8 AWG
PSR-22	243 ft	386 ft	616 ft	976 ft	1,551 ft	2,463 ft
PSR-52	134 ft	214 ft	341 ft	540 ft	859 ft	1,365 ft
PSR-53	134 ft	214 ft	341 ft	540 ft	859 ft	1,365 ft

Wiring Illustrations

HC

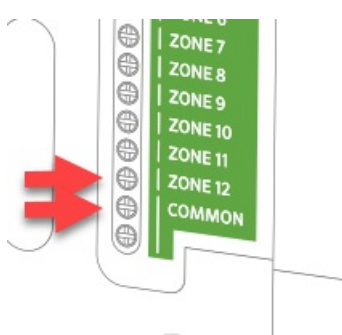

PRO-HC

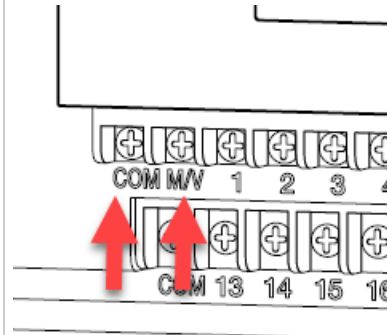

HPC

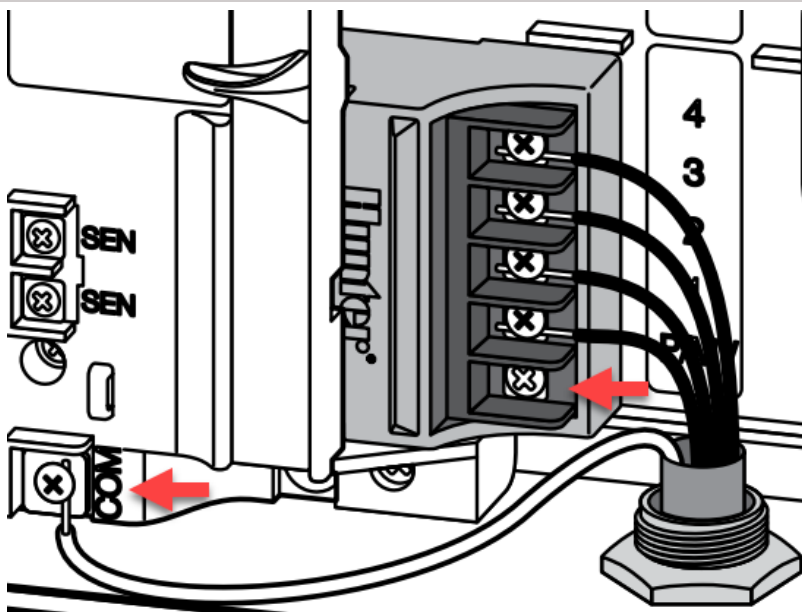

HCC

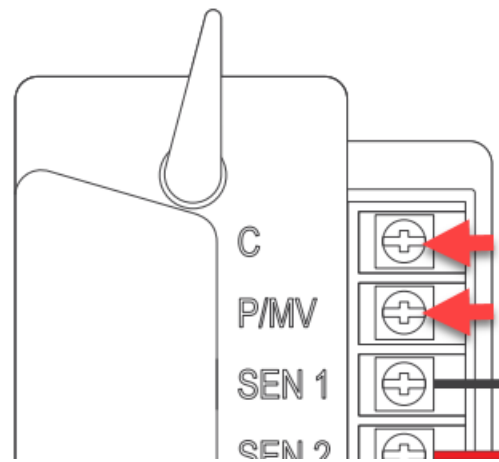

X2 w/WAND WiFi Module

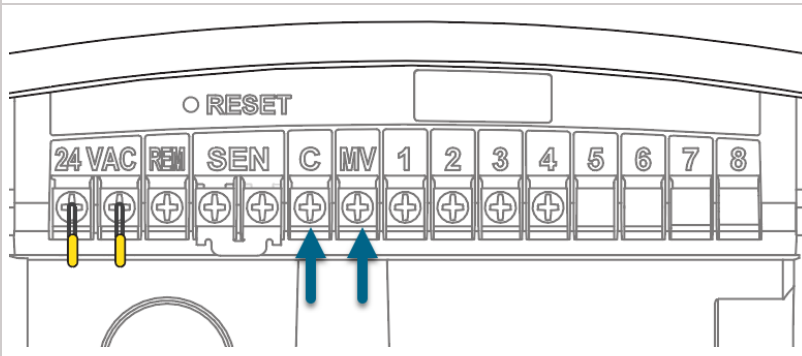

NOTE: With an HC Hydrowise controller, any one of your 6 or 12 zones can be configured to act as the pump start relay. We usually recommend wiring to the last zone that is not being used in the controller.

Wiring to Power Source

Connecting the pump start relay should only be done by a licensed electrician following local codes. Improper installation could result in shock or fire hazard.

1. To prevent electric shock, turn the main circuit-breaker switch to “off” prior to making electrical connections.
2. Assemble conduit piping and connect AC power from the power source to one side (LINE IN) of the relay.
3. Assemble conduit piping and connect wiring from the pump motor to the other side of the relay (LOAD OUT).
4. Check to make sure there are no exposed or loose connections.

Software Setup

This setup option is prompted when you first go through the initial setup wizard in the software.

The online instructions will refer to a **MASTER VALVE** but this same setting applies when using a **PUMP START RELAY (PSR)**.

NOTE: With an HC Hydrowise controller, any one of your 6 or 12 zones can be configured to act as the pump start relay. We usually recommend wiring to the last zone that is not being used in the controller.

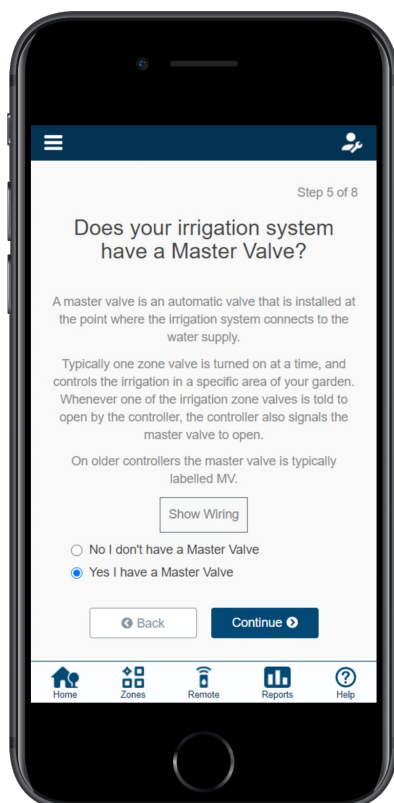

If you need to change this in the software after the setup wizard, refer to the instructions below.

1. Log in to your Hydrowise account
2. Click on **ZONES AND SCHEDULES** for the PC or **ZONES** if using the mobile app.
3. Choose **YES** from the drop-down menu above the zones. If you have an HC controller, choose the zone number to which you have the master valve wired.

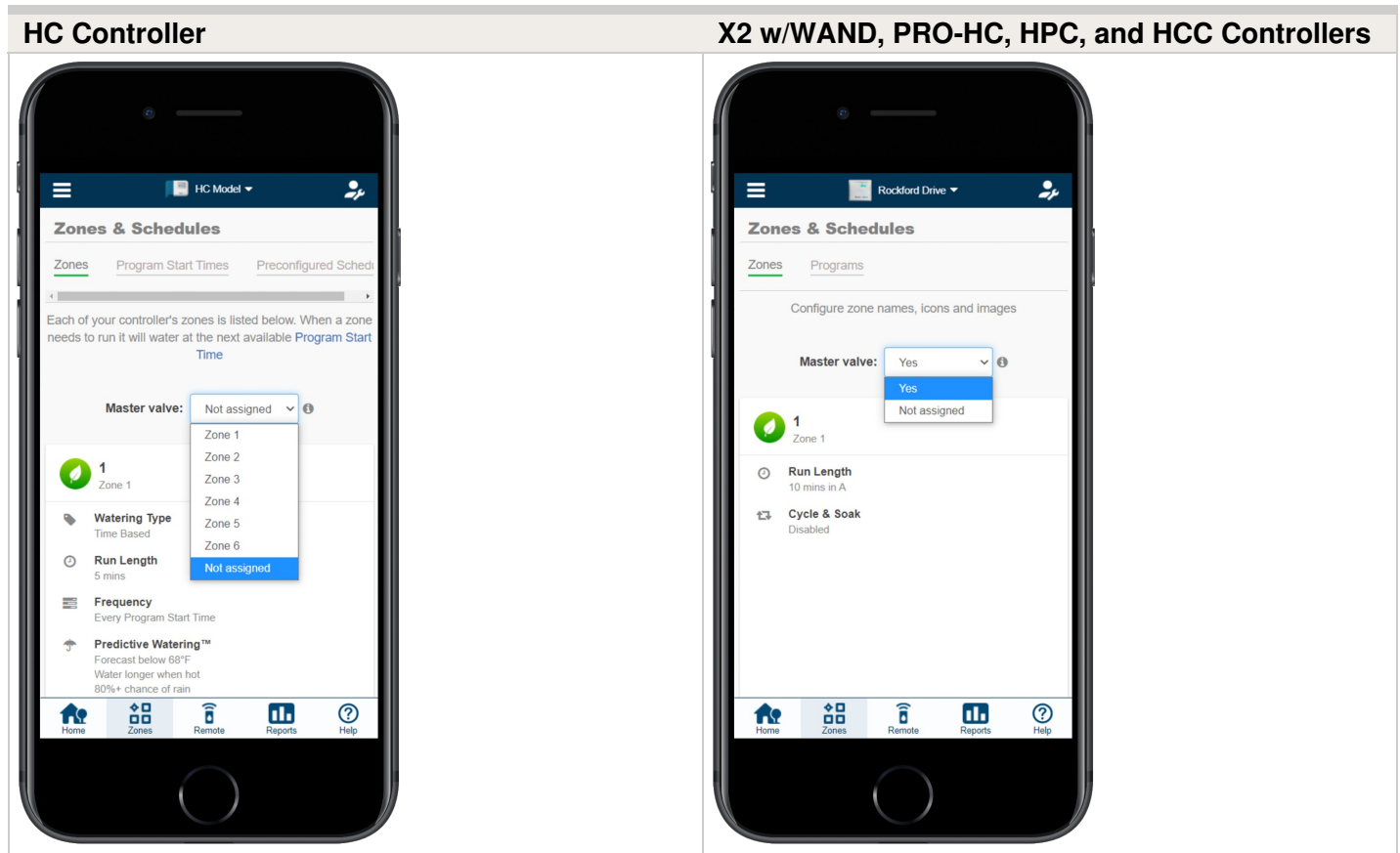

Pump Start Relay Operation per Station

When selecting a **PUMP START RELAY** to be on/off for an individual zone, you can edit the zone in **ZONES AND SCHEDULES** under **ADVANCED SETTINGS**. This option is useful when one zone is using city water and another is using water from a different source. This option is for X2 w/WAND, HPC, and HCC controllers only.

Follow the steps below to change this setting:

1. From the **ZONES AND SCHEDULES** page, click on the (✎) icon on the zone you would like to edit.
2. Click on **ADVANCED**, which is located on the top blue search section.
3. Select **USE GLOBAL MASTER VALVE SETTING** to keep this circuit on or select **DISABLE MASTER VALVE** to turn it off.

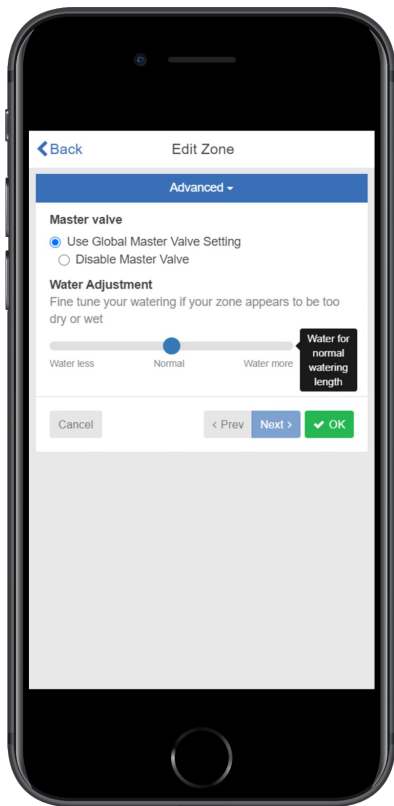

One Master Valve - Two Controllers

There are many times when two controllers are being supplied from a single POC (point of connection) or source of water. Hydrawise-ready controllers can be connected to a single master valve using a isolation relay (part number REL2). This device will allow for two controllers to share the same master valve with out any issues.

The few limitations include:

- Only one controller can operate at a time.
- A delay of at least five minutes between the operation of controller #1 and controller #2 is desirable.

- Electrical alerts will apply for each controller.

Steps for set up.

1. Wire the relay according to the drawing below.
2. Set up the master valve in the the app for both controllers using the normal instructions in the article [here](#) ^[16].
3. Set up a new master valve using the app for controller #2 as per normal instructions.

REL 2 is NEVER connected to high voltage. It is for 24 VAC devices only.

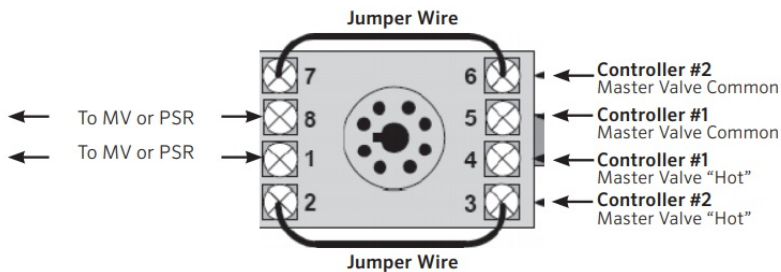

Master Valve Wiring and Software Setup

In this article, we will discuss the following topics:

- Brief Summary
- Operation Chart
- Wiring
- Software Setup
- Master Valve (P/MV) Operation per zone

Brief Summary

A master valve is a normally closed valve installed at the supply point of the mainline that opens only when the automatic system is activated. Zone valves are the individual valves that operate a group of sprinklers or drip emitters. Hydrawise controllers support 6 - 54

zone valves, depending on the model. Typically one zone valve is turned on at a time and controls the irrigation in a specific area of your garden. Whenever one of the irrigation zone valves is told to open by the controller, the controller also signals the master valve to open. The purpose of the master valve is to shut off the water to the irrigation system when none of the zone valves are operating.

IMPORTANT: The default setting for the Pump Start Relay/Master Valve is **NOT ASSIGNED (OFF)** in the software settings.

Operation Chart

Controller Model	Set Master Valve Operation
HC	ON or OFF by All Zones
PRO-HC	ON or OFF by All Zones
X2 w/WAND WiFi Module	ON or OFF by Zone or All Zones
HPC	ON or OFF by Zone or All Zones
HCC	ON or OFF by Zone or All Zones

Wiring

1. Route the master valve wire between valve location and the Hydrowise controller.
2. Attach the common wire to either solenoid wire. This is most commonly a white-colored wire. Attach a separate control wire to the remaining wire of each master valve solenoid. All wire splice connections should be done using waterproof connectors.
3. Route wire through the conduit or one of the openings on the bottom of the cabinet.
4. Strip 1/2" (13 mm) of insulation from the ends of all wires. Secure the valve common wire to the "**COM**" (Common) terminal. Attach the opposite control wire to the M/V terminal.

Wiring Illustrations

HC	PRO-HC

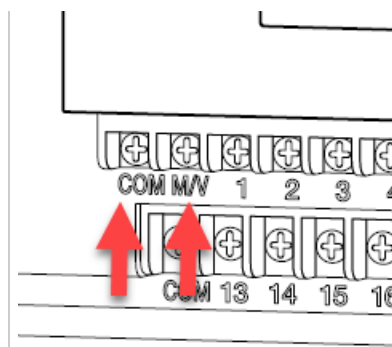
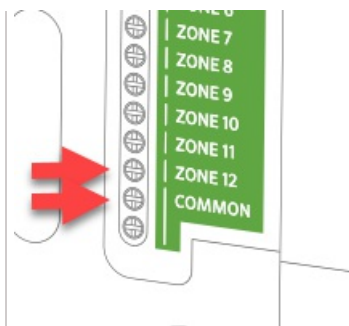

HPC

HCC

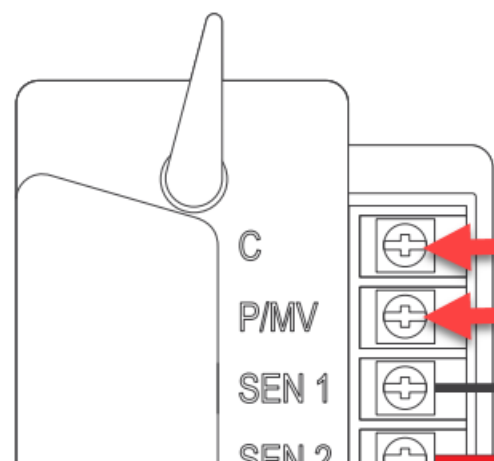
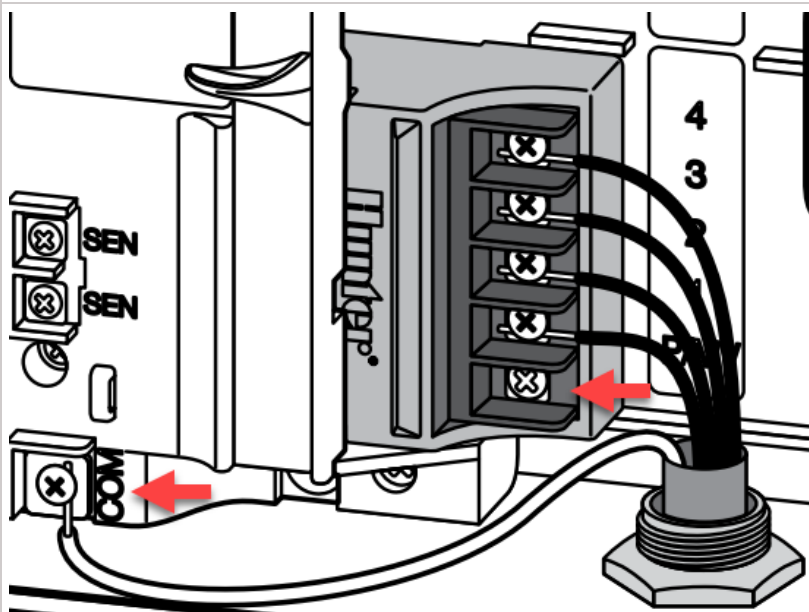

X2 w/WAND WiFi Module

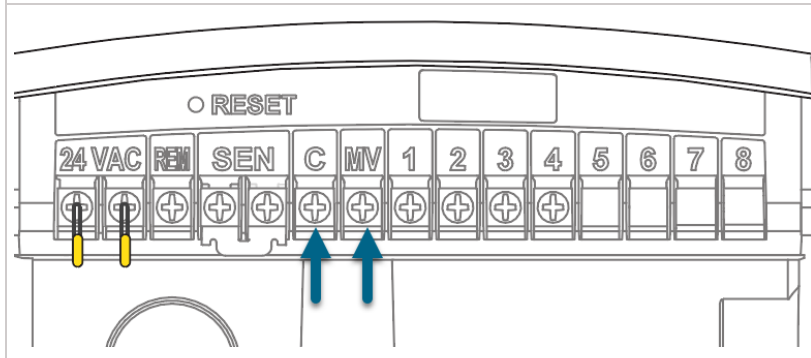

NOTE: With an HC Hydrawise controller, any one of your 6 or 12 zones can be configured to act as a master valve. We usually recommend wiring to the last zone not used in the controller.

Software Setup

This setup option is prompted when you first go through the initial setup wizard in the software.

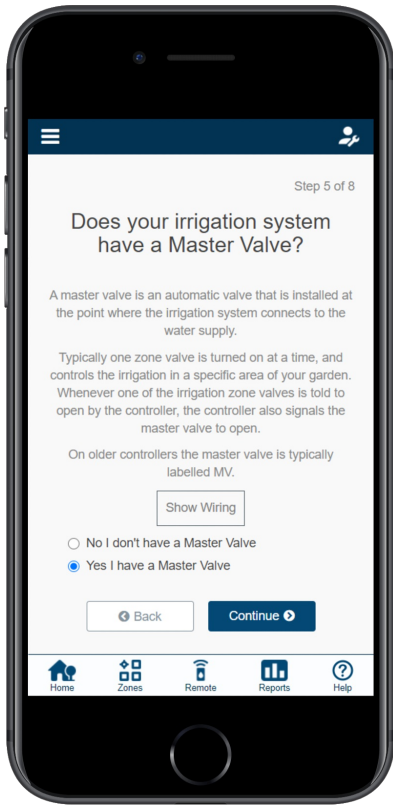

In the event, you need to change this in the software after the setup wizard, please refer to the instructions below.

1. Sign in to your [Hydrawise](#) ^[17] account
2. Click on **ZONES AND SCHEDULES** for the PC or **ZONES** if using the mobile app.
3. Choose **YES** from the drop-down above the zones. If you have an HC controller, then you choose the zone number that you have the master valve wired to.

HC Controller	X2 w/WAND, PRO-HC, HPC, and HCC Controllers

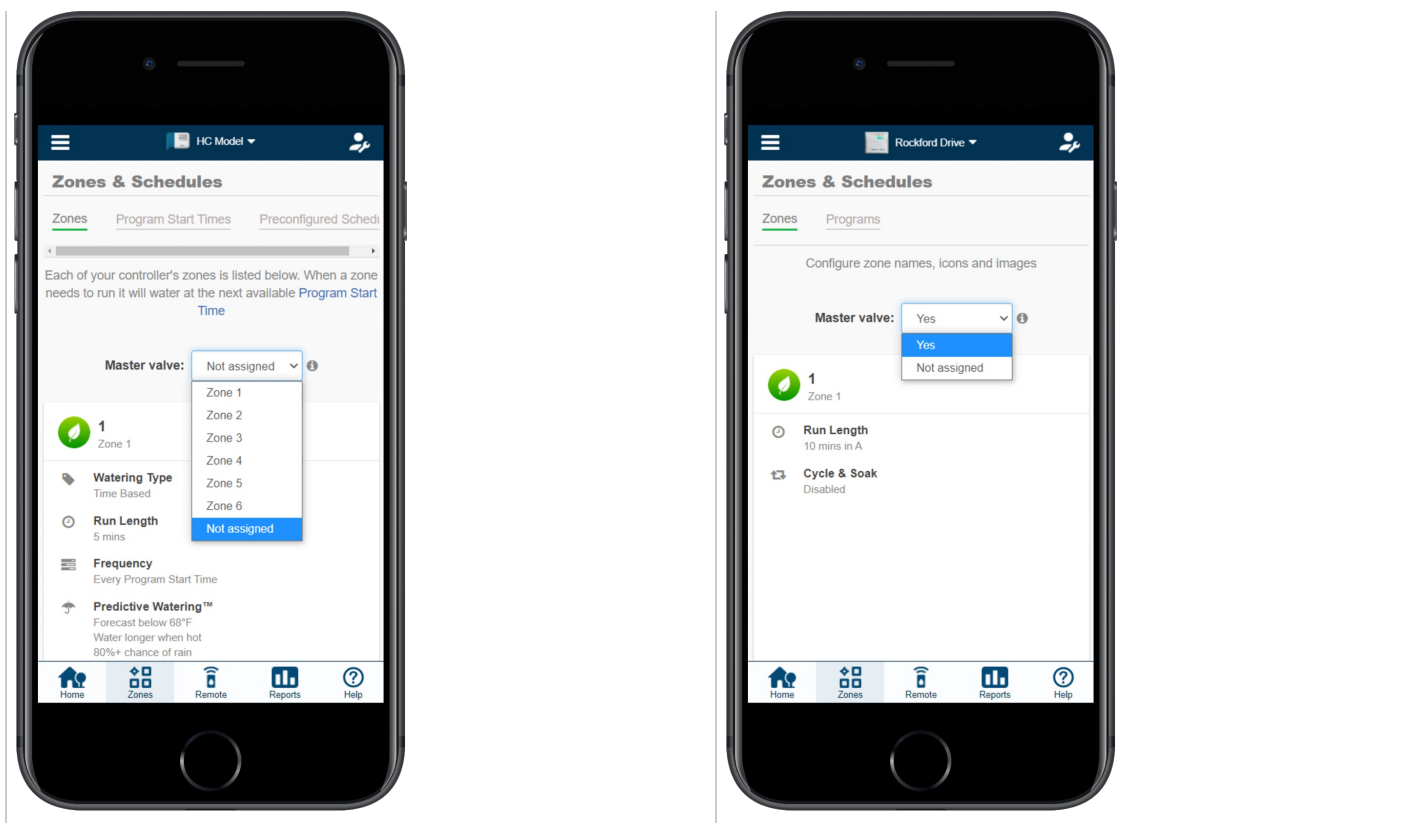

Master Valve (P/MV) Operation per Station

Selecting a master valve to be on/off for an individual zone, can be done when editing the zone in zones and schedules under advanced settings. This option is useful when one zone is using city water and another is using it from another source. This option is for X2 w/WAND, HPC, and HCC controllers only.

Please follow the steps below to change this setting.

1. From the **ZONES AND SCHEDULES** page, click on the (✎) icon on the zone you would like to edit.
2. Click on **ADVANCED** located on the top blue search section.
3. Select Use **GLOBAL MASTER VALVE SETTING** to keep this circuit on or select **DISABLE MASTER VALVE** to turn this circuit off.

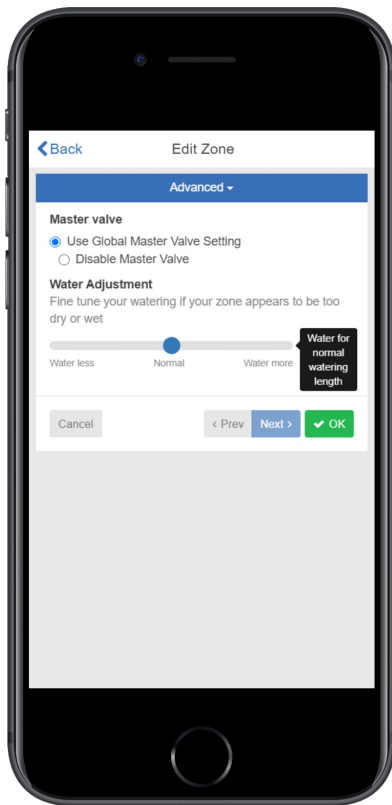

Sprinklers Running with the Controller Off or Unplugged

There are two reasons why sprinklers would continue to run with the controller **Off** or **Unplugged**:

- It's possible your valves were opened manually. Locate your valve box(es) and turn the solenoid(s) clockwise until snug. The solenoid is located on top of the valve and looks like a cylinder with two wires protruding out of it.

- It's also possible that debris in the valve is causing the diaphragm to remain open.

To fix this problem:

1. Disassemble the valve.
2. Rinse all parts with clean water.
3. Reassemble the valve.

If you cannot locate your valves, contact the contractor who installed the system.

Cleaning the Diaphragm on a Hunter Valve

